

Toward zero-power ICT

Luca Gammaitoni

NiPS Laboratory, University of Perugia

March 5th, 2015 - EPFL

Plan of the presentation

- 1) Some motivations
- 2) Some modeling
- 3) Some considerations
- 4) Some conclusions

Some motivations

A growing number of people accepted to join the so-called internet-of-things scenario

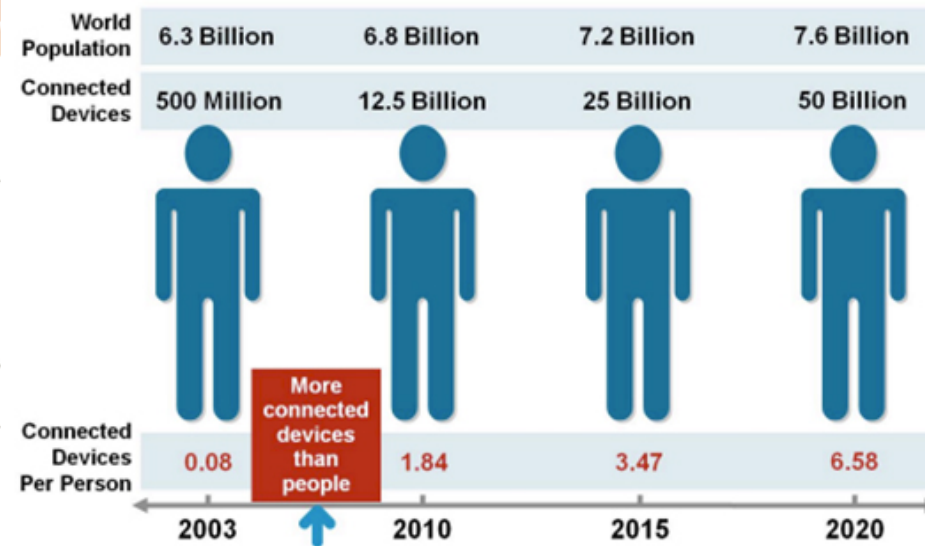

Source: Cisco IBSG, April 2011

Before this scenario becomes a reality the device powering issue needs to be addressed and solved.

The challenge of efficient management of energy is a key aspect to consider in computing systems, especially for applications in smart sensors and Internet of Things devices.

European Commission **Workshop** on "Energy-Efficient Computing Systems, dynamic adaptation of Quality of Service and approximate computing". Nov. 27 2014 - Brussels

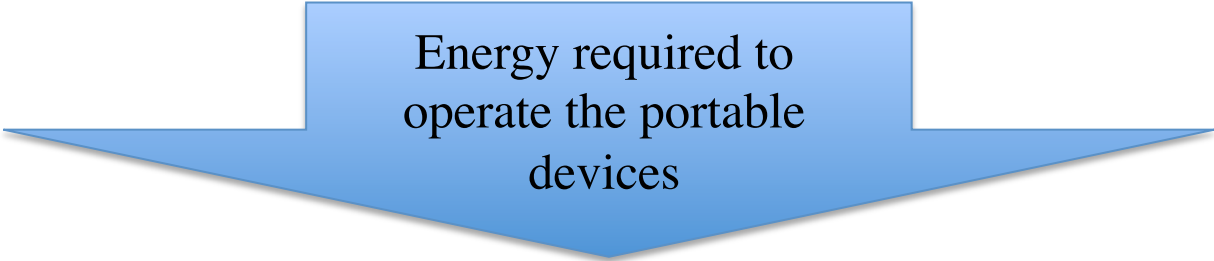

Energy required to
operate the portable
devices

We need to bridge the gap by acting on both arrows



Energy available from
portable sources

Some modeling

Some interesting questions:

Why all the energy ends up in heat? What does it mean “energy dissipation”? Can be avoided?

What is the role of information? Is this a physical quantity that affects the energy transformations?

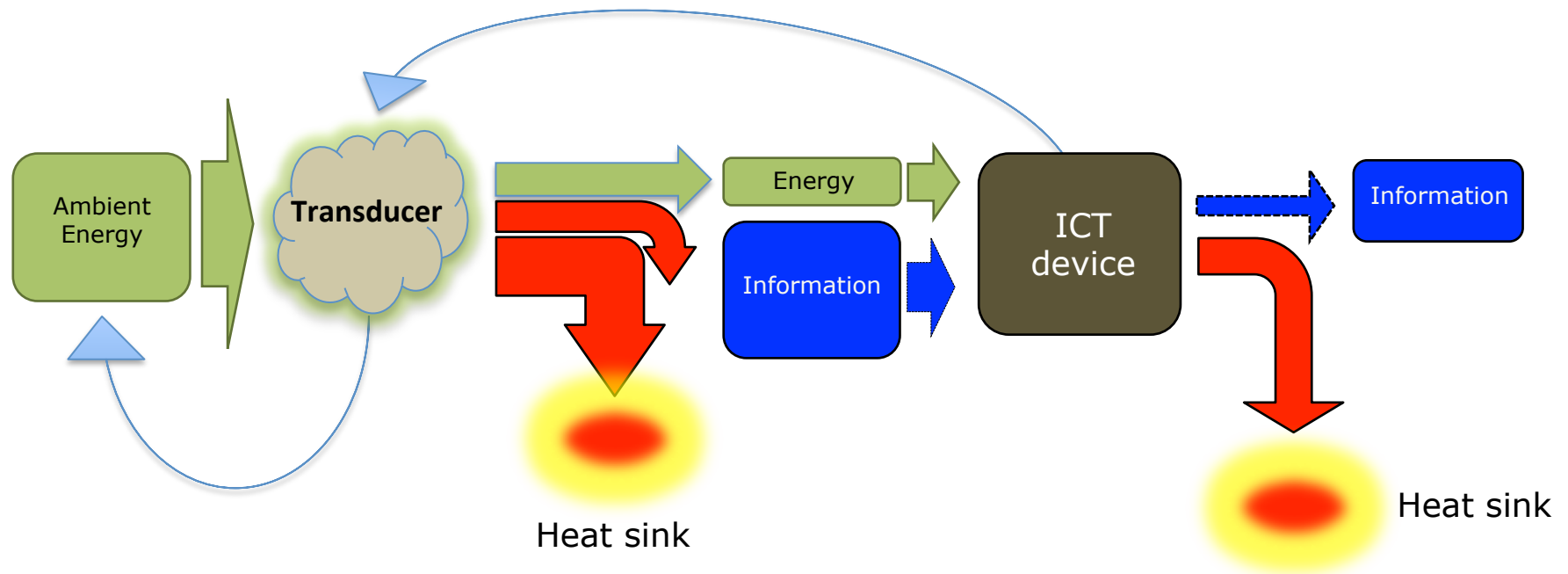

We need a physical model...

Two physical systems:

They transform energy

They have many d.o.f. (presence of fluctuations)

They are operated in a changing environment

~~Thermodynamics~~

~~Statistical mechanics~~

Non-equilibrium statistical mechanics

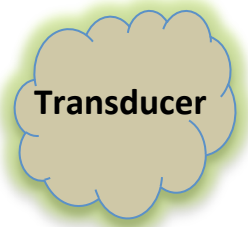

In this framework we can describe the device behavior in terms of few relevant d.o.f. via a procedure called “adiabatic elimination” or “coarse graining approach”: we exchange the dynamics of a *not small isolated system* with *small not isolated system*.

Two physical systems whose dynamical behavior can be described in the framework of non-equilibrium statistical mechanics.

Langevin equation approach

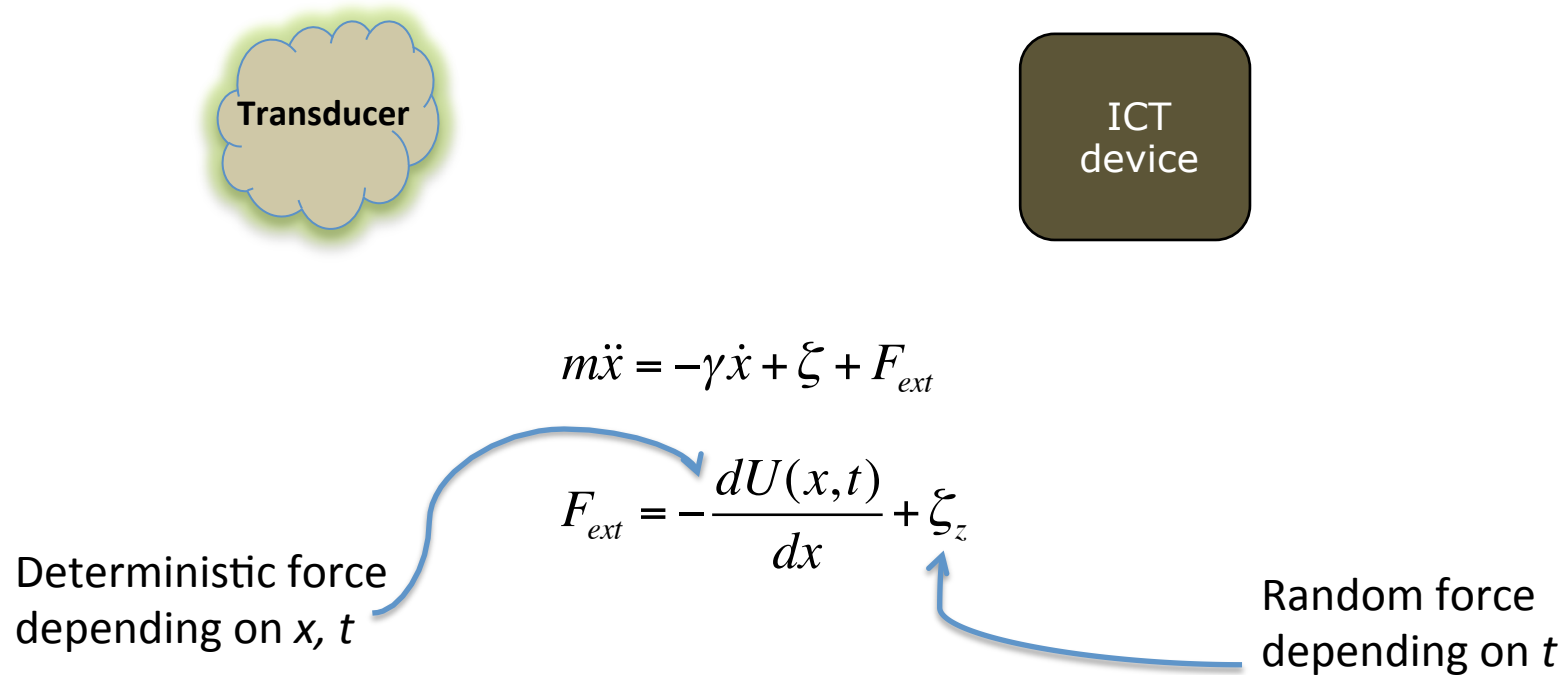

If $F_{ext} \gg \zeta$ then the thermal noise contribution can be ignored

$$m\ddot{x} = -\frac{dU(x,t)}{dx} - \gamma\dot{x} + \zeta_z$$

Two physical systems whose dynamical behavior can be described in the framework of non-equilibrium statistical mechanics.

Langevin equation approach

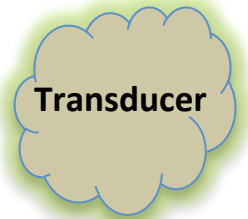

Two physical systems whose dynamical behavior can be described in the framework of non-equilibrium statistical mechanics.

Langevin equation approach

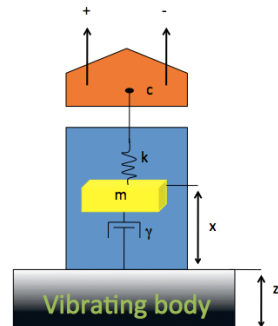

ICT device

(example from vibration harvester)

$$m\ddot{x} = -\frac{dU(x)}{dx} - \gamma\dot{x} - c(x, V) + \zeta_z + \zeta$$

$$\dot{V} = F(\dot{x}, V)$$

$$\langle \zeta(t) \zeta(0) \rangle = 2 K_B T \gamma \delta(t)$$

Vibration Energy Harvesting: Linear and Nonlinear Oscillator Approaches, Gammaitoni, Luca, Vocca Helios, Neri Igor, Travasso Flavio, and Orfei Francesco , Sustainable Energy Harvesting Technologies - Past, Present and Future, InTech ed. (2011)

Two physical systems whose dynamical behavior can be described in the framework of non-equilibrium statistical mechanics.

Langevin equation approach

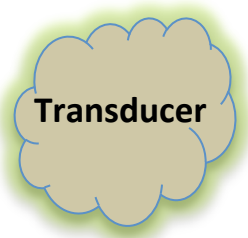

Two physical systems whose dynamical behavior can be described in the framework of non-equilibrium statistical mechanics.

Langevin equation approach

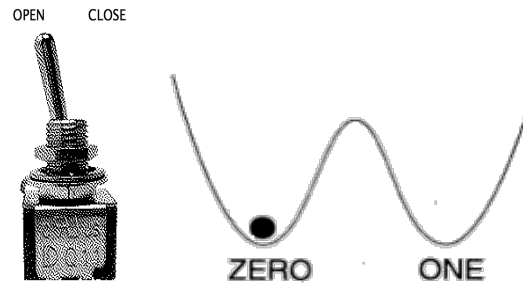
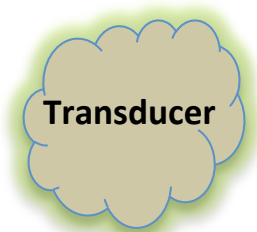

(example from a digital binary switch)

$$m\ddot{x} = -\frac{dU(x)}{dx} - \gamma\dot{x} + F_{sw} + \zeta$$

$\langle \zeta(t) \zeta(0) \rangle = 2 K_B T \gamma \delta(t)$

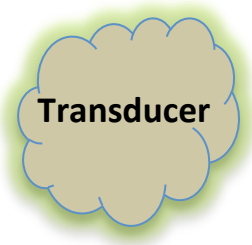

Langevin equation approach

$$m\ddot{x} = -\frac{dU(x,t)}{dx} + \zeta_z - \gamma\dot{x} + \xi$$



This is a stochastic dynamics whose solution $x(t)$ appears like



Probability density $P(x,t)$.

$P(x,t)dx$ represents the probability for the observable x to be in $(x, x+dx)$.

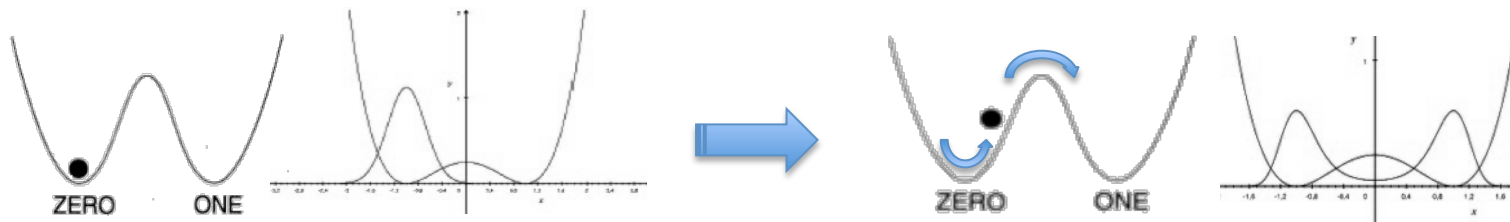

$P(x,t)$ is a deterministic quantity and its time evolution of can be described in terms of the associated Fokker-Planck equation.

Some considerations

The device powering issue:

- 1) How much energy is needed to power a device ?
- 2) Where does the device get the needed energy ?

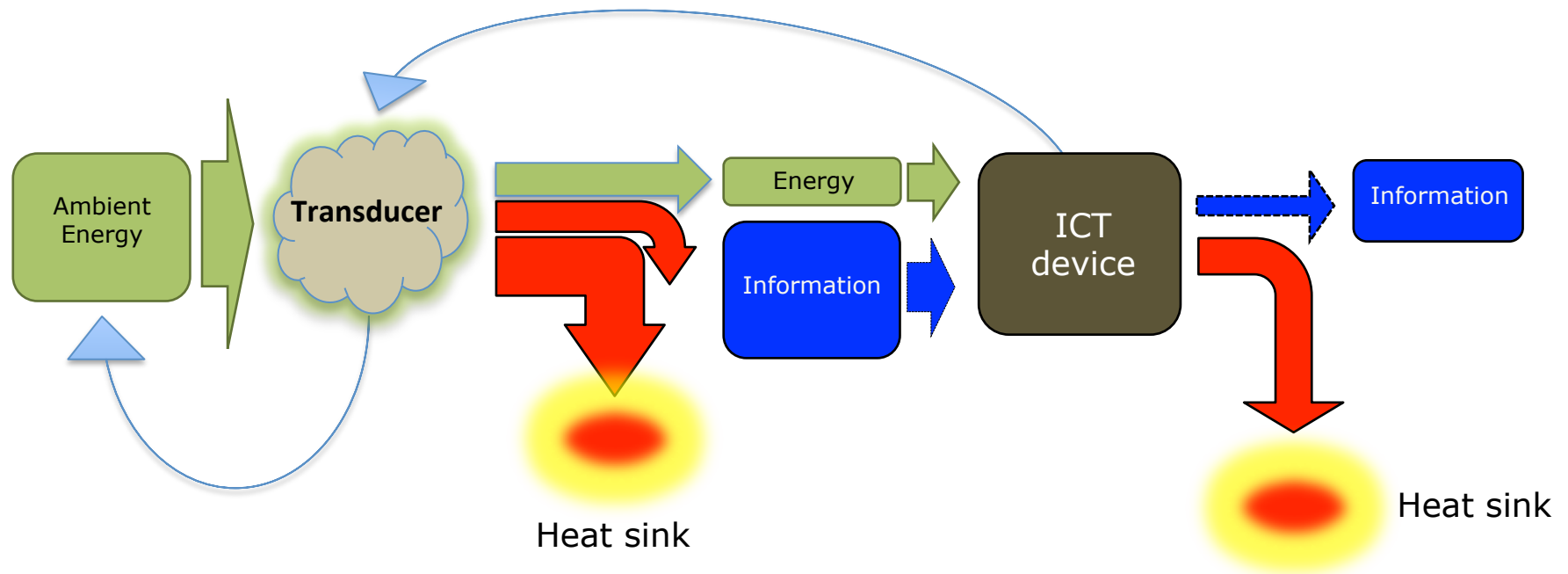

An **ICT device** is an info-thermal machine that inputs **information** and **energy** (under the form of work), processes both and outputs information and energy (mostly under the form of heat).

The device powering issue:

- 1) How much energy is needed to power a device ?
- 2) Where does the device get the needed energy ?

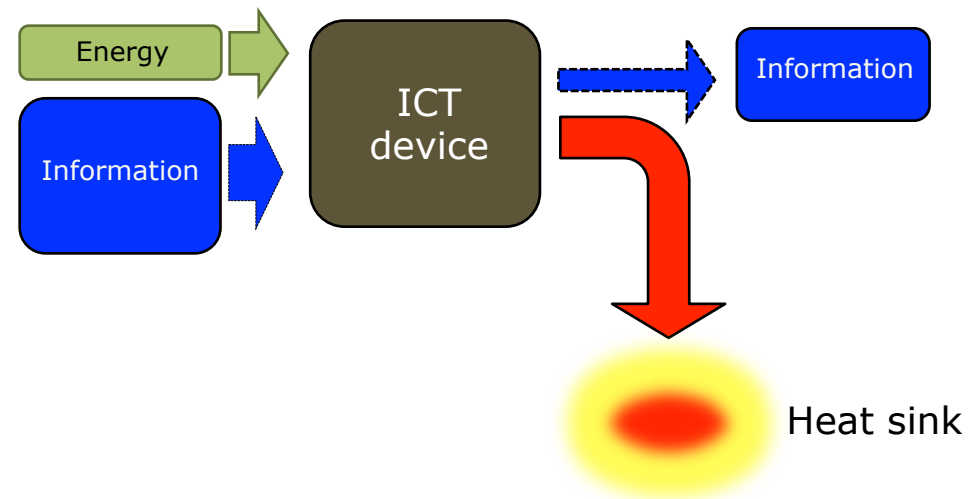

An **ICT device** is an info-thermal machine that inputs **information** and **energy** (under the form of work), processes both and outputs information and energy (mostly under the form of heat).

1) How much energy is needed to power a device ?

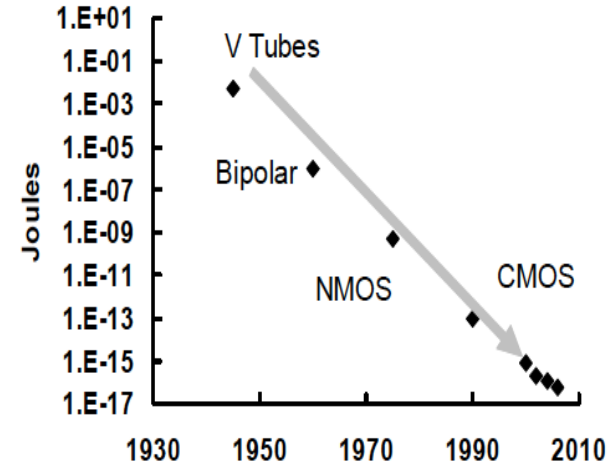
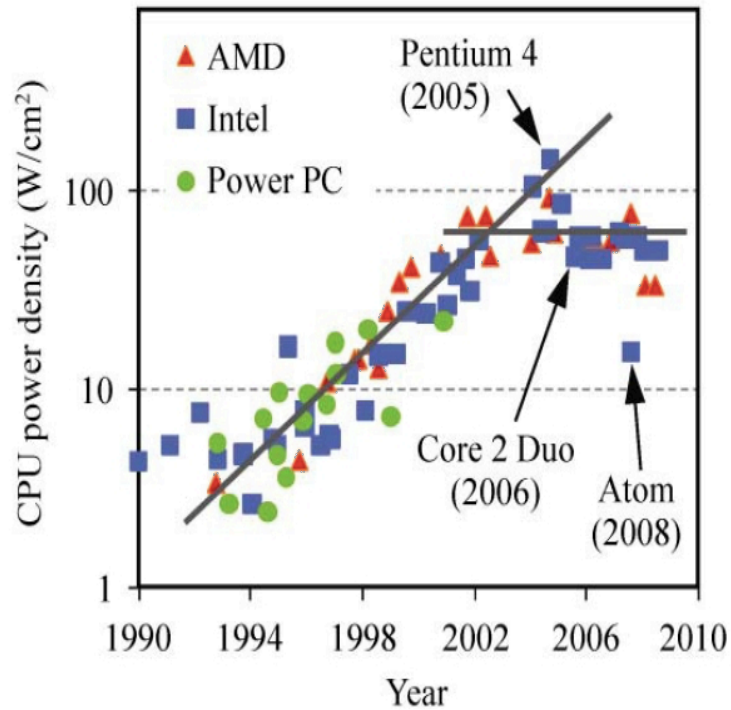

Shekhar Borkar, *Electronics Beyond Nano-scale CMOS*, Design Automation Conference, 2006 43rd ACM/IEEE

E. Pop, *Energy Dissipation and Transport in Nanoscale Devices*, Nano Res (2010) 3: 147–169

“...the resulting power density for these switches at *maximum packing density* would be on the order of $1MW/cm^2$ – orders of magnitude higher than the practical air-cooling limit..”

Jeffrey J. Welser
The Quest for the Next Information Processing Technology ,
2008

Is it possible to operate a computing device with zero energy expenditure ?

Toward zero-power computing

YES



A computing device....
(slide rule)



YES

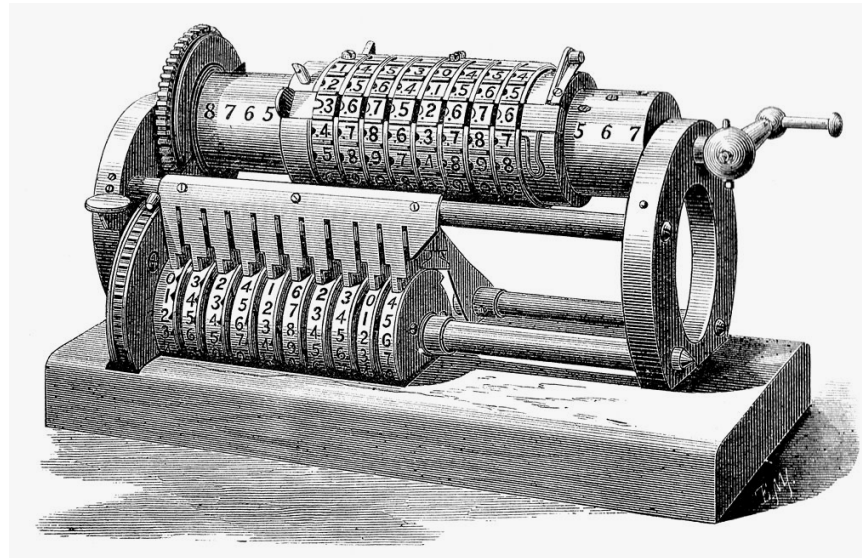

A computing device....

Is it possible to operate a binary (digital) computing device
with zero energy expenditure ?



a binary (digital) computing device

How does the binary (digital computation) work?

In modern computers the information is processed via networks of logic gates that perform all the mathematical operations through assemblies of basic Boolean functions. E.g. the NAND gate that due to its universal character can be widely employed to be networked in connected networks in order to perform any other logic functions.

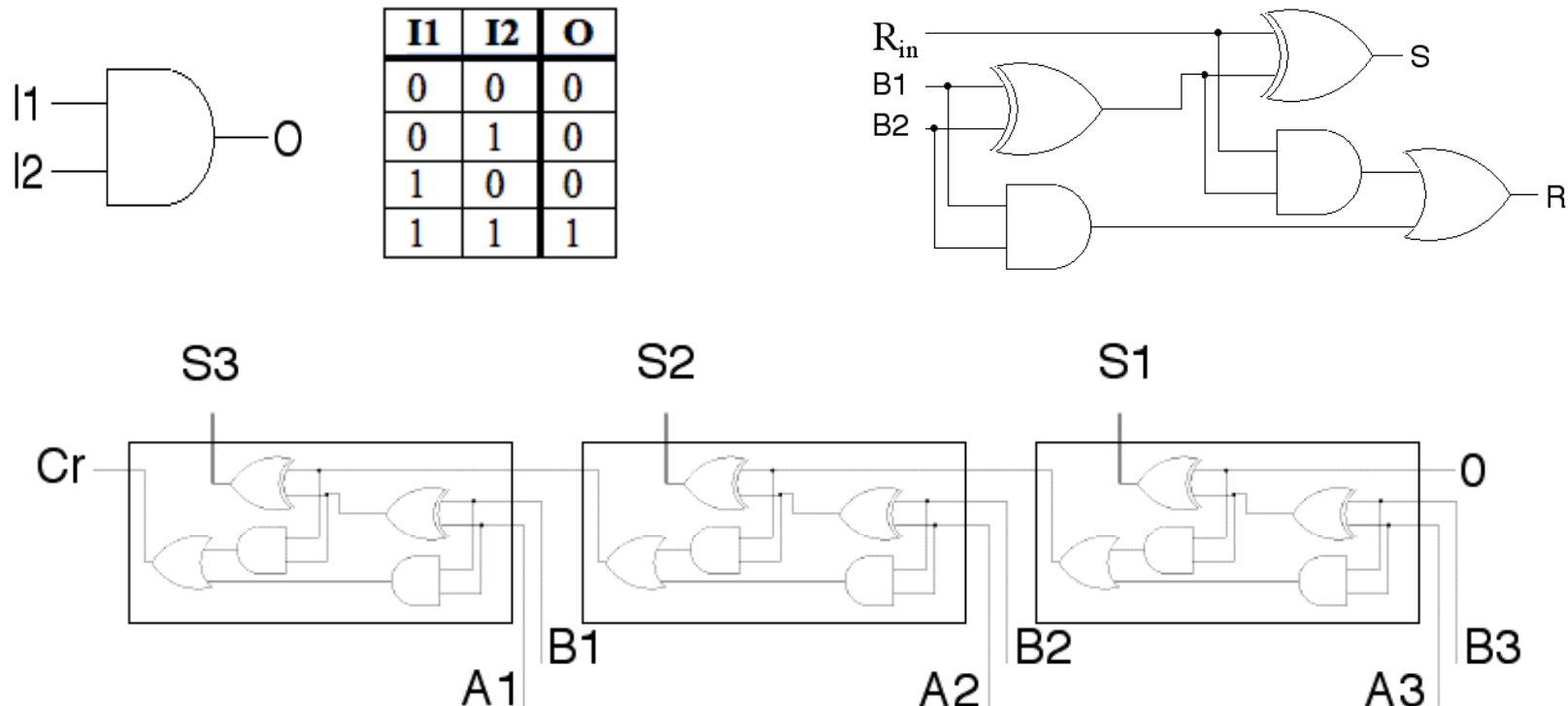

Logic gates and switches

In a practical computer, the logic gate function is realized by some material device. The bit value is represented by some physical entity (signal) like electric current or voltage, light intensity, magnetic field,...etc.

Modern logic gate devices are made by assembling more elementary units: i.e. the **transistors**.

A transistor is an electronic device that here performs the role of a **switch** by letting or not-letting the electric current go pass through.

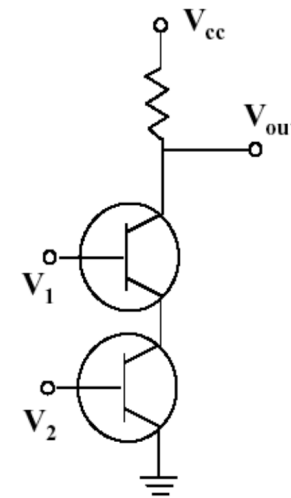

Es: the NAND gate with 2 transistor

Switches based on capacitors

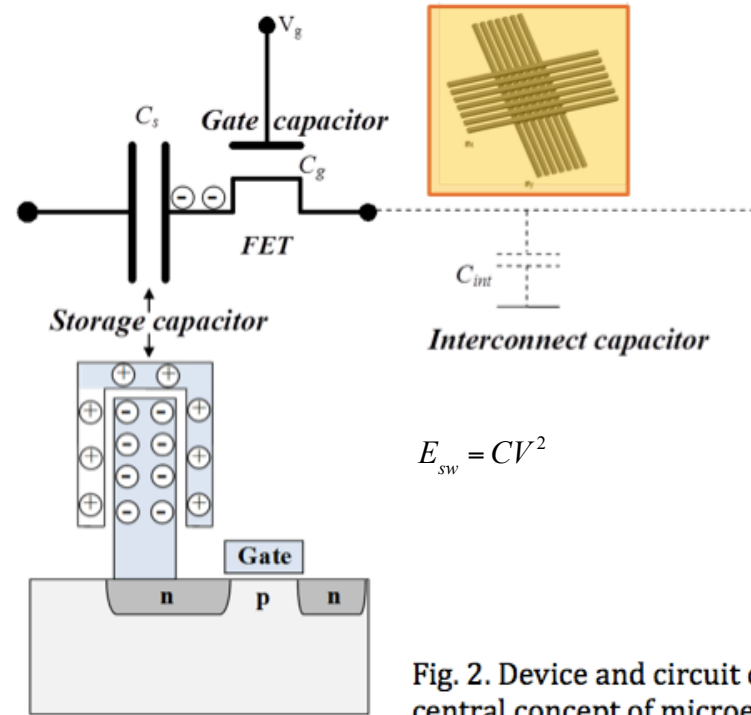

$$E_{sw} = CV^2$$

Fig. 2. Device and circuit capacitance as a central concept of microelectronics.

$$E_{sw} = CV^2$$

$$P = \alpha E_{sw} f = \alpha CV^2 f$$

Minimum Energy of Computing, Fundamental Considerations, L. Victor Zhirnov, Ralph Cavin and Luca Gammaitoni in the book "ICT - Energy - Concepts Towards Zero - Power Information and Communication Technology" InTech, February 2, 2014

ICT - Energy

The present trend...

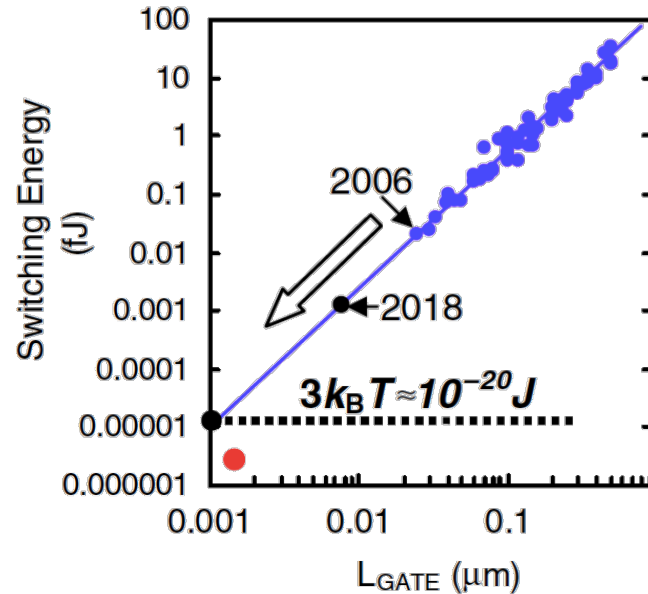

Research directions and challenges in nanoelectronics
R. K. Cavin¹, V. V. Zhirnov, D. J. C. Herr¹, Alba Avila and J. Hutchby, 2006

Thus, the search for alternative switches is presently very active.

To take on this grand challenge, the **Nanoelectronics Research Initiative** (NRI) (nri.src.org) was formed in 2004 as a consortium of Semiconductor Industry Association (SIA) (www.sia-online.org) companies to manage a university-based research program as part of the Semiconductor Research Corporation (SRC) (www.src.org).

ICT - Energy

Question:

Is there a fundamental physical limit to the minimum energy needed to switch?

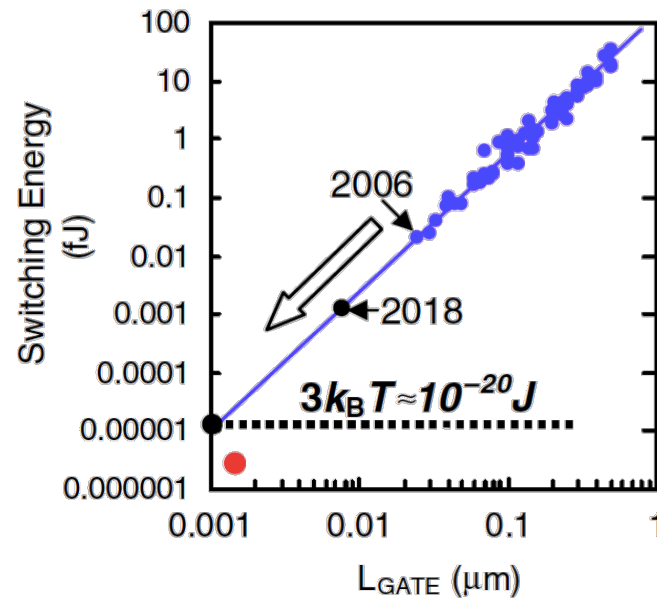

There is no general agreement on the answer... and present limits are associated with charge based computation.

The Physics of switches



In order to describe the physics of a switch we need to introduce a **dynamical model** capable of capturing the main features of a switch.

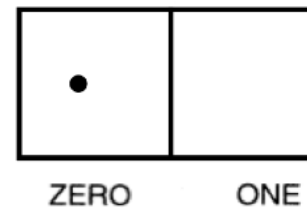
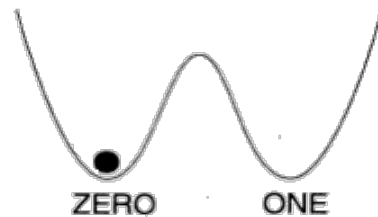

The two states, in order to be dynamically stable, are separated by some energy barrier that should be surpassed in order to perform the switch event.

This situation can be mathematically described by a second order differential equation like:

$$m\ddot{x} = -\frac{d}{dx}U(x) - m\gamma\dot{x} + F$$

The Physics of switches

According to this model if we want to produce a switch event we need to apply an external force F capable of bringing the particle from the left well (at rest at the bottom) into the right well (at rest at the bottom).

Clearly this can be done in more than one way.

As an example we start discussing what we call the **first procedure**: a three-step procedure based on the application of a **large and constant force** $F=-F_0$, with $F_0 > 0$

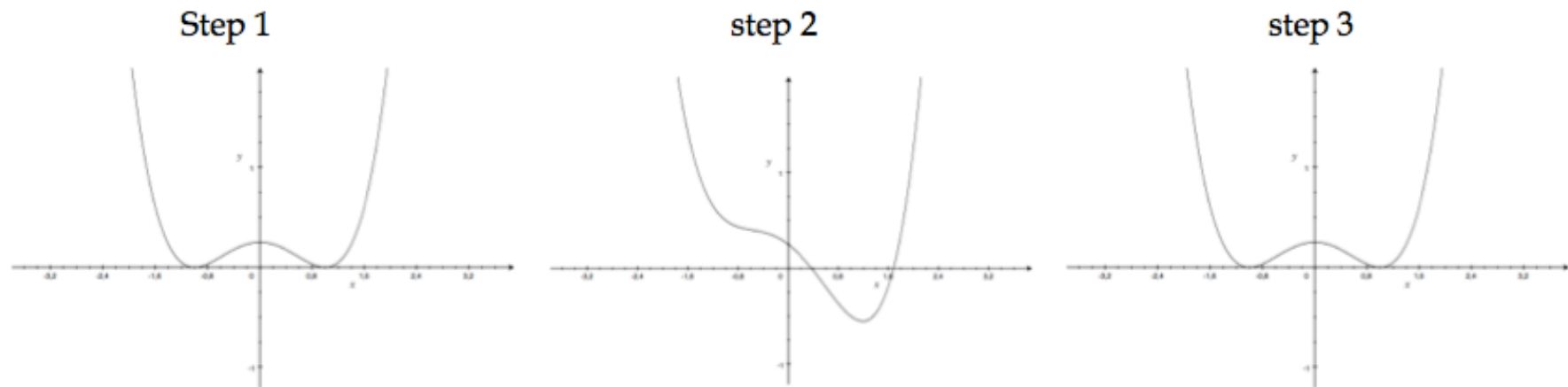

We can ask what is the minimum work that the force F has to perform in order to make the device switch from 0 to 1 (or equivalently from 1 to 0).

The work is computed as:

$$L = \int_{x_1}^{x_2} F(x) dx \quad \text{Thus } L = 2 F_0$$

The Physics of switches

Is this the minimum work?

Let's look at this other procedure (**second procedure**):

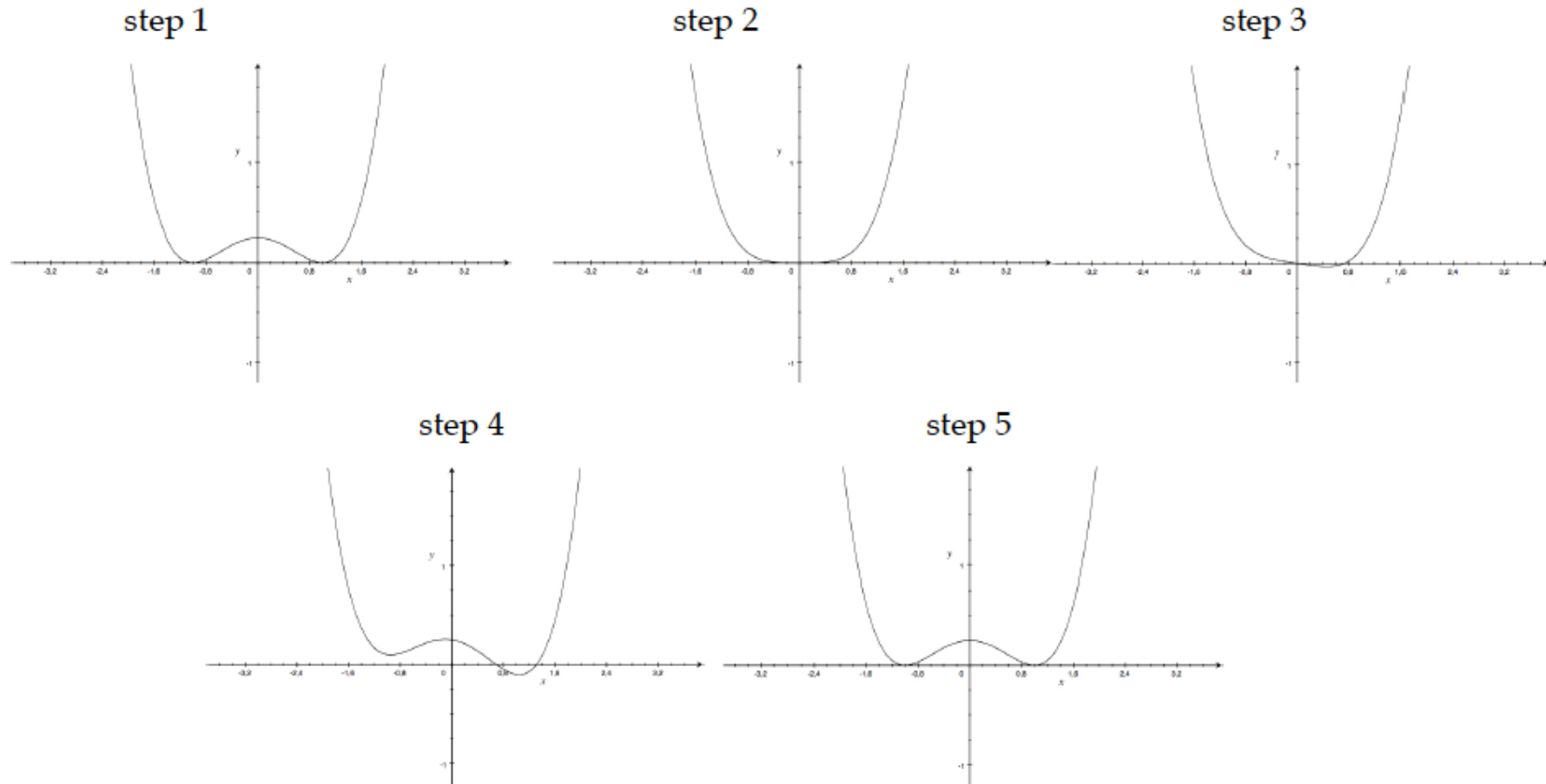

The only work performed happened to be during step 3 where it is readily computed as $L_1 = 2 F_1$. Now, by the moment that $F_1 \ll F_0$ we have $L_1 \ll L_0$

The Physics of realistic switches

This analysis, although correct, is quite naïve, indeed. The reason is that we have assumed that the work performed, no matter how small, is completely dissipated by the frictional force.

In order to be closer to a reasonable physical model we need to introduce a fluctuating force and thus a Langevin equation:

$$m\ddot{x} = -\frac{d}{dx}U(x) - m\gamma\dot{x} + \xi(t) + F$$

The relevant quantity becomes the probability density $P(x,t)$ and

$$p_0(t) = \int_{-\infty}^0 P(x,t)dx \quad \text{and} \quad p_1(t) = \int_0^{+\infty} P(x,t)dx$$

Represent the probability for our switch to assume “0” or “1” logic states

This calls for a reconsideration of the equilibrium condition

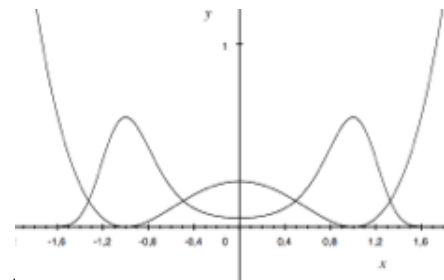

The Physics of realistic switches

In this new physical framework we have to do with exchanges of both work and heat (constant temperature transformation approximation).

Thus we have to take into account both the exchanges associate with work and the changes associated with entropy variation.

Entropy here is defined according to Gibbs:

$$S = -K_B \sum_i p_i \log p_i$$

Based on this new approach let's review the previous procedure:

The Physics of realistic switches

Based on this new approach let's review the previous procedure:

step 1

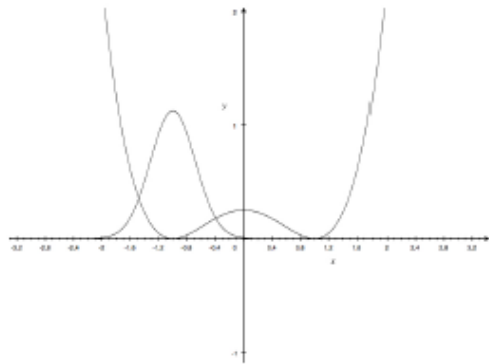

step 2

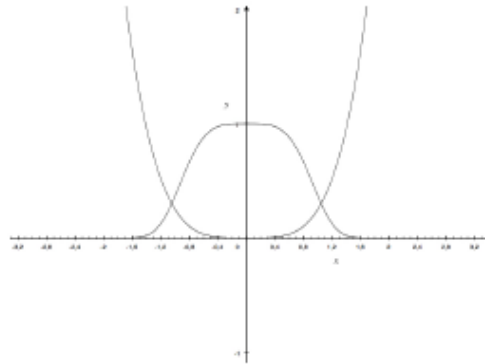

step 3

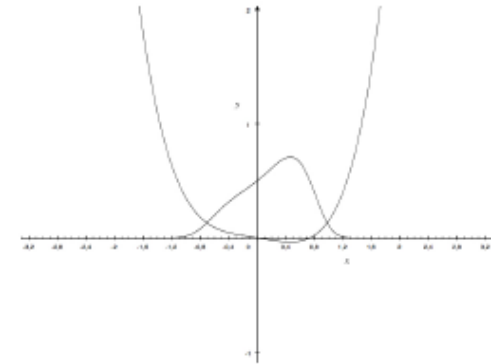

step 4

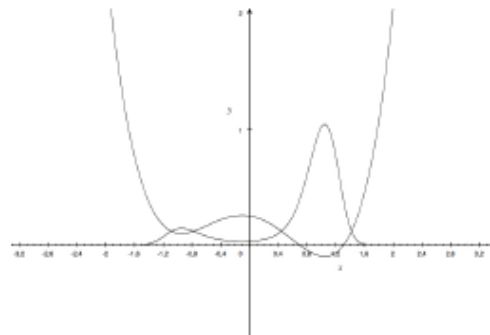

step 5

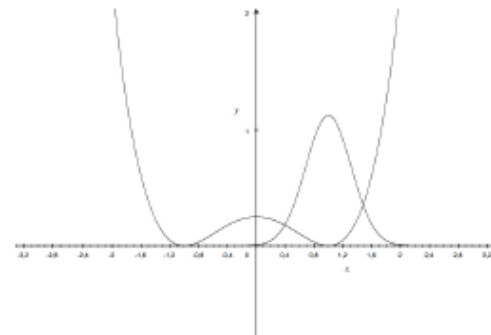

we observe a change in entropy:

$$S_1 = S_5 = -K_B \ln 1 = 0 \quad S_2 = -K_B (\frac{1}{2} \ln \frac{1}{2} + \frac{1}{2} \ln \frac{1}{2}) = K_B \ln 2.$$



The Physics of realistic switches

Based on these considerations we can now reformulate conditions required in order to perform the switch by spending zero energy:

- 1) The total work performed on the system by the external force has to be zero.
- 2) The switch event has to proceed with a speed arbitrarily small in order to have arbitrarily small losses due to friction.
- 3) The system entropy never decreases during the switch event.

Is it possible?

Yes... at least in principle...

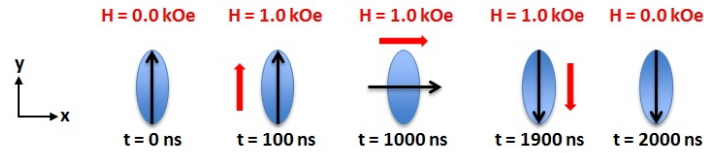

Magnetic nano dots

Single cylindrical element of permalloy (NiFe) with dimensions 50 x 50 x 5 nm³

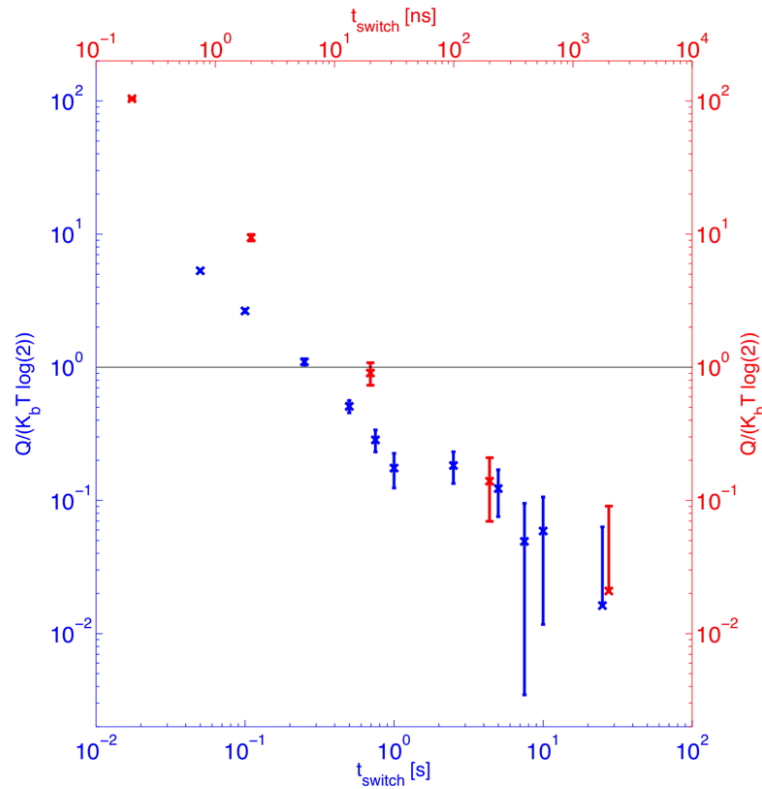

Entropy changes

Entropy stays constant

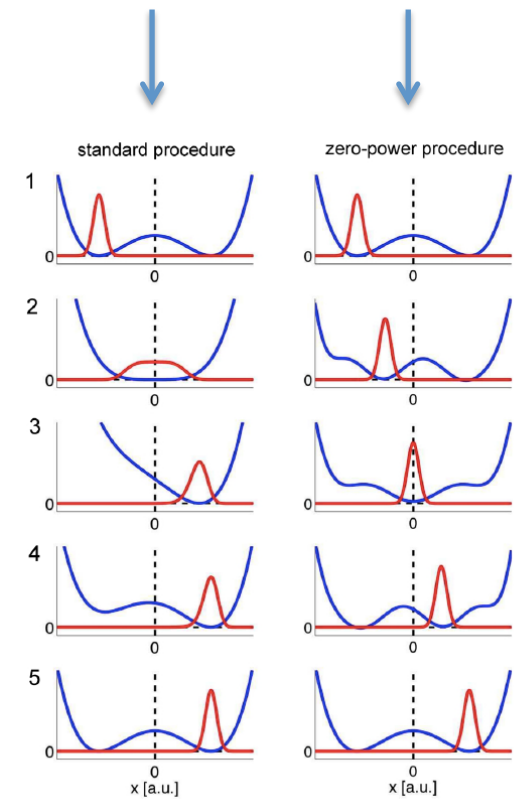

More info available at www.landauer-project.eu

The device powering issue:

- 1) How much energy is needed to power a device ?
- 2) Where does the device get the needed energy ?

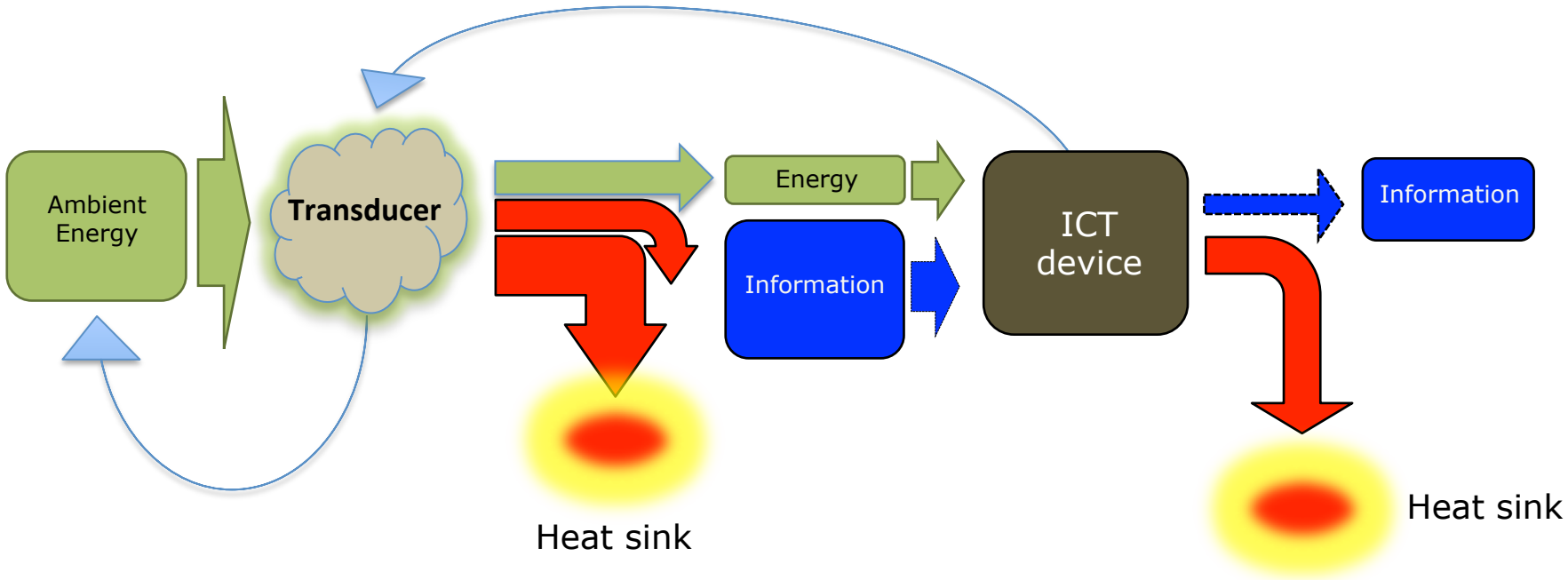

The device powering issue:

- 1) How much energy is needed to power a device ?
- 2) Where does the device get the needed energy ?

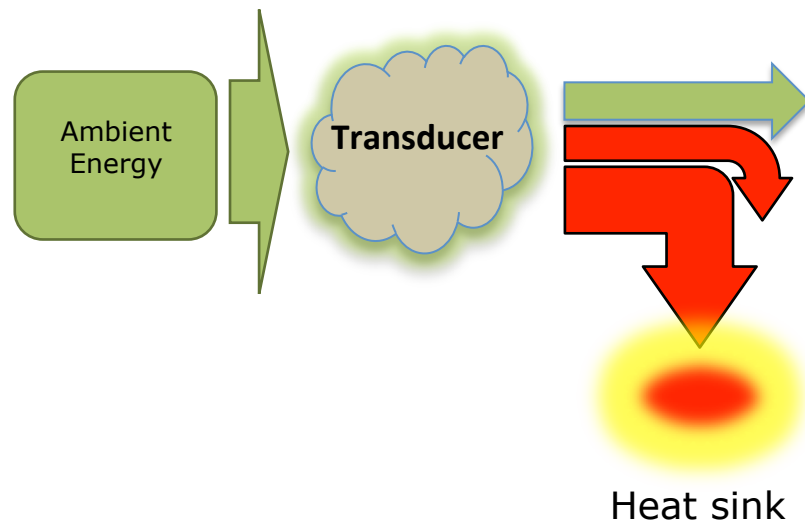

Clearly this energy is obtained from the ambient...

The device powering issue:

- 1) How much energy is needed to power a device ?
- 2) Where does the device get the needed energy ?

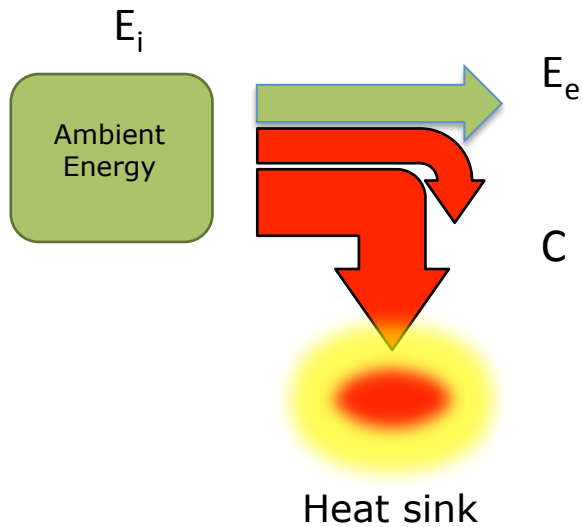

Energy is conserved....

$$E_e = E_i - C$$

Question: can we make $C = 0$?

C is the energy dissipated during the transformation. $m\ddot{x} = -\frac{dU(x,t)}{dx} + \zeta_z - \gamma\dot{x} + \zeta$

$C=C(\gamma)$ and γ is associated with the relaxation to equilibrium and depends on the characteristics of the device/material.

The device powering issue:

- 1) How much energy is needed to power a device ?
- 2) Where does the device get the needed energy ?

C is the energy dissipated during the transformation. $m\ddot{x} = -\frac{dU(x,t)}{dx} + \zeta_z - \gamma\dot{x} + \zeta$

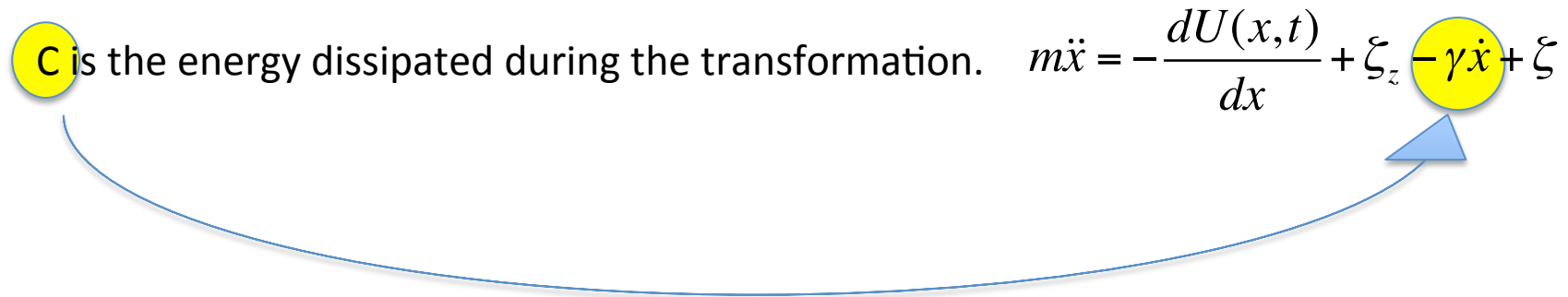

The usual solution is to go very slow, i.e. to minimize \dot{x}

Good news: In principle there is no physical law that forbids to make $C = 0$

Bad news: This might affect the power we can use in the device

$C=C(\gamma)$ can be a function of time and change with the dissipation process.
Viscous damping, thermo-elastic damping, structural damping, ...

Generalized Langevin equation $m\ddot{x} = -\frac{dU(x,t)}{dx} + \zeta_z - \int_{-\infty}^t \gamma(t-\tau) \dot{x} d\tau + \zeta$

The device powering issue:

- 1) How much energy is needed to power a device ?
- 2) Where does the device get the needed energy ?

$$m\ddot{x} = -\frac{dU(x,t)}{dx} + \xi_z - \gamma\dot{x} + \xi$$

Finally, the role of the potential energy $U(x,t)$

Beyond the linear oscillator approach

$$U(x) \neq \frac{1}{2}ax^2$$

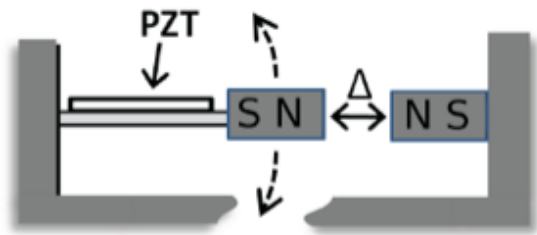

$$U(x) = \frac{1}{2}k_e x^2 + (Ax^2 + B\Delta^2)^{-3/2}$$

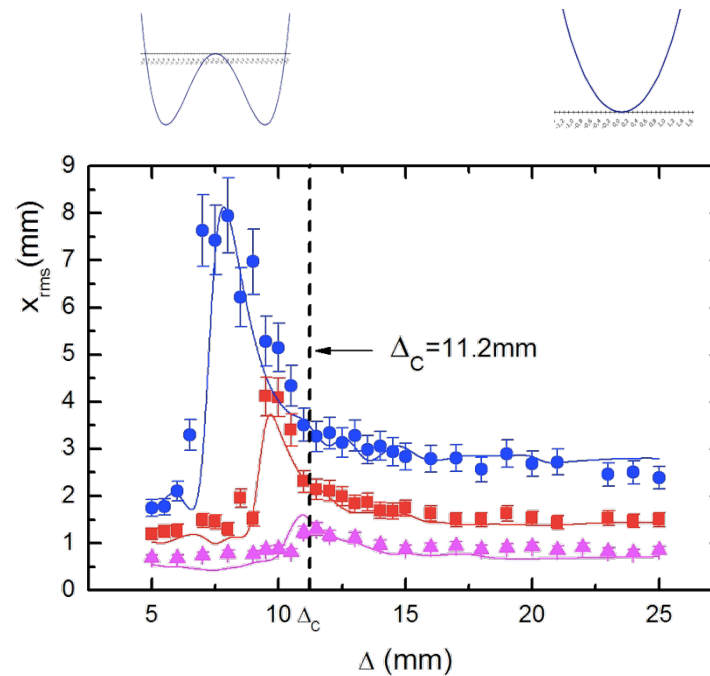

Nonlinear Energy Harvesting, F. Cottone; H. Vocca; L. Gammaitoni, Physical Review Letters, 102, 080601 (2009)

NANOPOWER

To know more: www.nanopwr.eu



Some conclusions

ICT-Energy consortium/community

Participant no.	Participant organisation name	Part. short name	Country
1 (Coordinator)	Università di Perugia	UNIPG	IT
2	Roskilde University	RUC	DK
3	Karlsruher Institut fuer Technologie	KIT	DE
4	Barcelona Supercomputing Center	BSC	SP
5	Ecole Polytechnique Federale de Lausanne	EPFL	CH
6	Aalborg University - Denmark	AAU	DK
7	Hitachi Europe Limited	HCL	UK
8	University of Bristol	UNIVBRIS	UK
9	University of Glasgow	UGLA	UK
10	University College Cork, National University of Ireland	TNI-UCC	IR



Home | ICT-Energy

www.ict-energy.eu

Home Project Consortium News Events Publications Contacts Login

ICTenergy

SEARCH Search

NiPS Summer School 2014 "ICT-Energy: Energy management at micro and nanoscales for future ICT"

ICT-ENERGY PHD FORUM
Call for Submissions

NANOENERGY LETTERS
Subscribe to the NANOENERGY newsletter to be informed on our latest news!
Subscribe

Previous issues

UPCOMING EVENTS

Welcome to the ICT-Energy project website!
The goal of the project is to create a coordination activity among consortia involved in the ICT-Energy

www.ict-energy.eu

ICT-ENERGY

L E T T E R S

www.ict-energyletters.eu

In the last three issues we have started a special session devoted to the publication of original scientific papers. Instruction for submission procedure is available at:
www.ict-energyletters.eu/submission



Next issue Jul 15th 2015

Take-home message:

Focusing only on energy harvesting produces misconception.

The focus should be on energy transformation processes.

Both ends of the gap should be addressed if we want to move from labs to market.

What future for the subject of **energy harvesting / autonomous devices** ?

Bright!

The problem of powering small (and not so-small) autonomous devices has been already addressed and solved by nature. There is plenty of devices that process information (and actuate) while transforming energy from low entropy sources into heat.



None of them carries disposable batteries !

To know more

- www.nipslab.org

- www.ict-energy.eu

- Book: *ICT - Energy - Concepts Towards Zero - Power Information and Communication Technology*, InTech, February 2, 2014.

Luca Gammaitoni, NiPS Laboratory, University of Perugia (IT)

